



# SLIDE RAIL SHORING SYSTEMS



THE LEADING PRODUCER & DISTRIBUTOR OF TRENCH SHIELDING & SHORING EQUIPMENT SINCE 1995

# Pro-Tec Equipment

## Slide Rail Shoring Systems

### What is Pro-Tec Equipment's Slide Rail?

The Pro-Tec Equipment Slide Rail System is a dig and push style system. With its modular, flexible design the system can comply with a wide variety of shapes and sizes. The Pro-Tec Slide Rail Shoring System is installed from the top down and removed from the bottom up, minimizing size of excavations, soil disturbances and restoration time and cost. The installation is done with low vibration, providing soil support for excavations, adjacent structures and existing utilities.

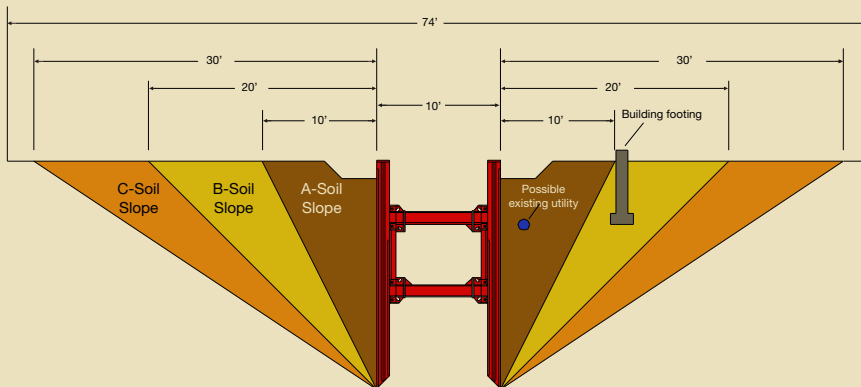

### When to use slide rail

- Bad soil conditions
- Lift/pump station installations
- Tight quarters
- Fuel tank installations
- C.I.P. foundations and footings
- Boring and receiving pits
- Soil remediations
- And many other uses

### Why use a slide rail?

The illustration above shows the use of slide rail vs. sloping, based on a project 20' deep, 10' wide x 30' long, with C-soils.

Using the slide rail system, the project will require an overall width of 14' at the top of the excavation (including the OSHA-required 2' set-back on each side for equipment and spoil pile), requiring approximately 223 cubic yards of soil to be removed/replaced. Using the sloping method for the same project, in accordance

with the slope of 1½:1 (H:V) required for C-soils, would result in a total excavation width of 74' at the top—or 890 cubic yards of soil to be removed/replaced!

Based on a conservative figure of \$15/ cubic yard for fill (not including hauling or machine time), the estimated cost to replace the 223 cubic yards of fill removed when using the slide rail system is \$3,375. With the sloping method, the estimated cost to replace the 890 cubic

yards of material removed would be \$13,350. That is almost \$10,000 more in fill dirt costs alone (not including hauling or machine time) when using the sloping method!

Simply put, the slide rail system, when used in the proper situation, can save the user significant time and money!

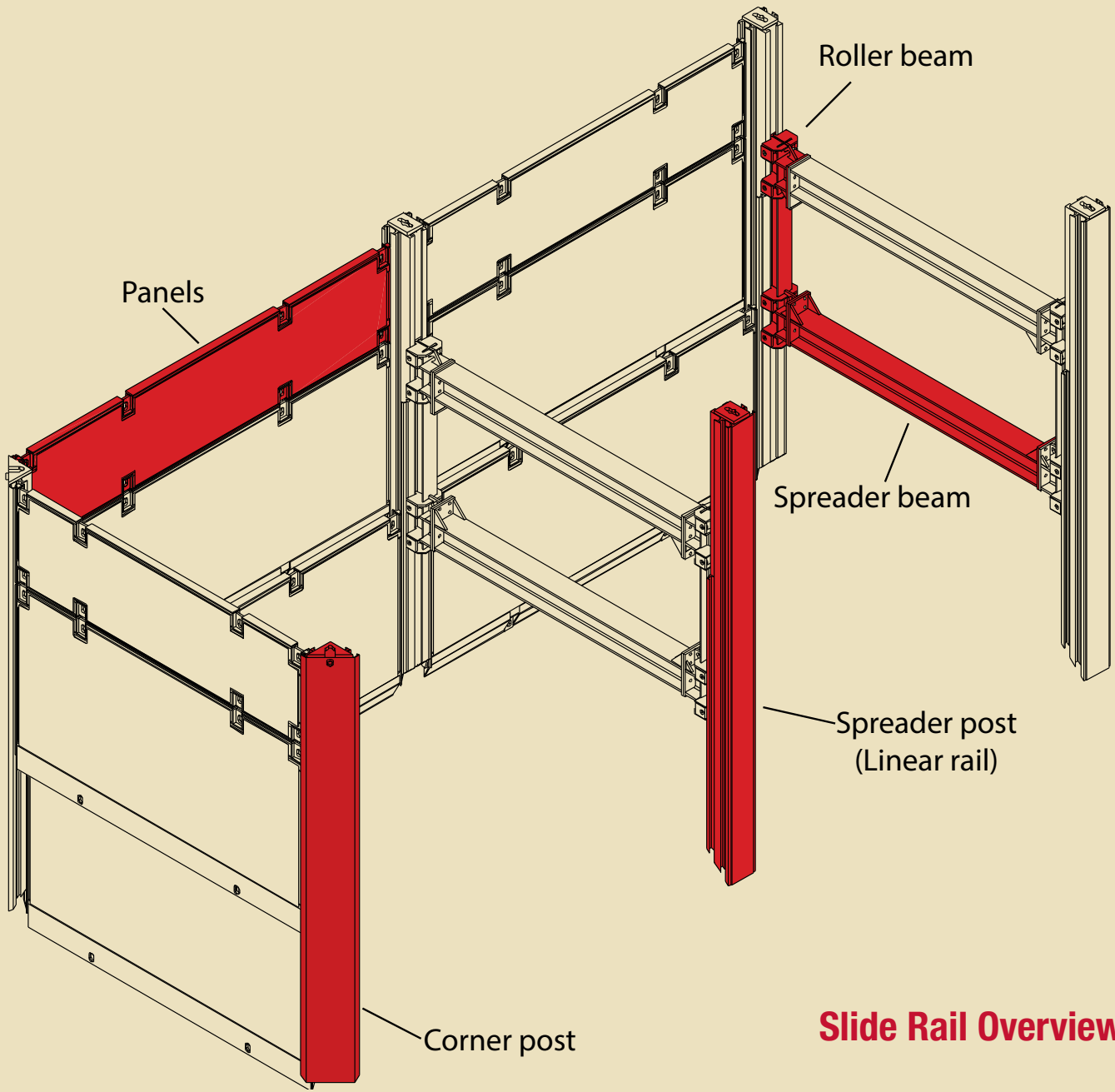

### Slide Rail Overview

# GENERAL INSTALLATION AND REMOVAL

## INSTALLATION

1

After initial pilot cut, first outer panel and corner post are put into place.

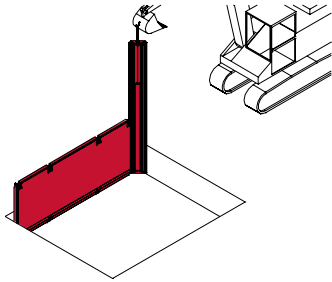

2

Second panel and corner post forms a right angle.

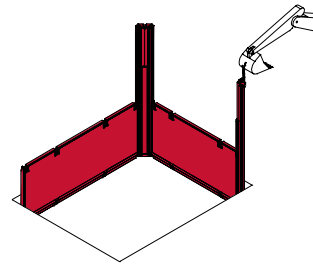

3

With outer panels and posts in position...

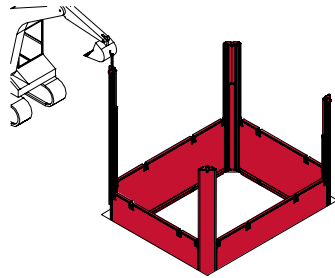

4

excavation continues...

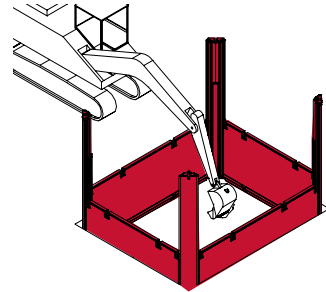

5

while outer panels and corner posts are pushed to proper depth with excavator.

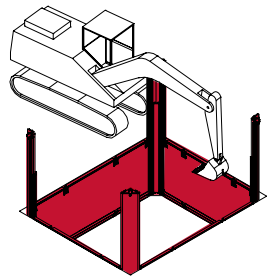

6

Excavation is deepened and panels are lowered into inside tracks.

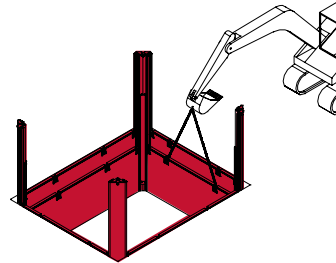

7

Excavator continues to dig and push the inside panels and corner posts...

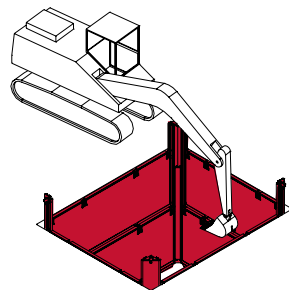

8

until desired depth is reached.

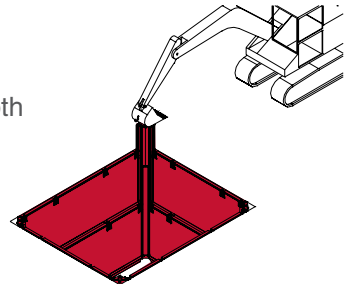

## REMOVAL

9

Extract inner panels as back filling and compaction is started.

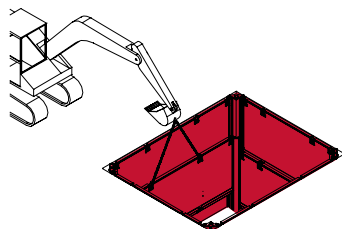

10

Outer panels and corner posts are extracted as back filling and compaction is completed.

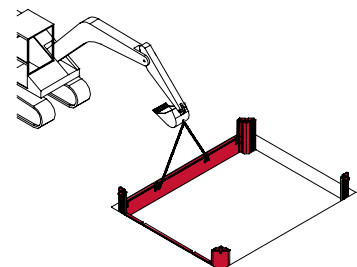

# SLIDE RAIL SYSTEMS



## SINGLE TRACK

Designed to be used for smaller, shallow excavations, such as fuel tanks, building footing and linear pipeline work, the single slide rail system provides protection at a depth range of 4' to 12'. All panels sit in a single track, enabling the removal of panels in a single lift, making it an ideal system for 60,000 to 80,000 lb. machines.

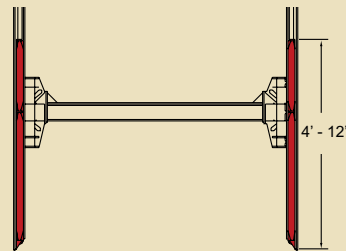

ROLLER BEAM

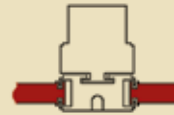

SINGLE SPREADER POST  
(LINEAR RAIL)



SINGLE CORNER POST

## DOUBLE TRACK

The most popular of the slide rail systems, the double slide rail system provides protection at a depth range of 12' to 20'. This system is designed to be used with 80,000 to 100,000 lb. machines, on jobs ranging from manhole installations, lift stations, soil remediations and anything in between.

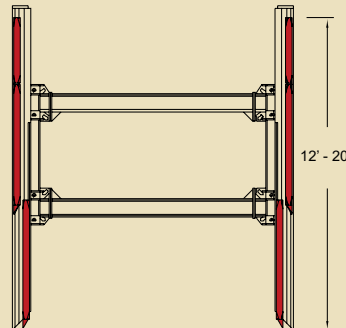

ROLLER BEAM

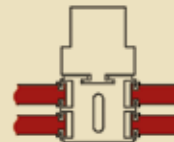

DOUBLE SPREADER POST  
(LINEAR RAIL)



DOUBLE CORNER POST

## TRIPLE TRACK

The triple slide rail system, providing protection at a depth range of 20' to 32', is ideal for any application requiring a deep cut. Designed to be used with 100,000-plus lb. machines, the triple slide rail system is able to be used on any job on which a slide rail system can be used.

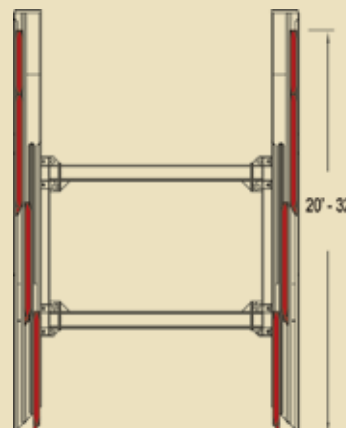

ROLLER BEAM

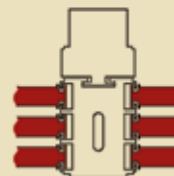

TRIPLE SPREADER POST  
(LINEAR RAIL)



TRIPLE CORNER POST

# MODULAR DESIGN

permits installation of a wide variety of shapes and sizes

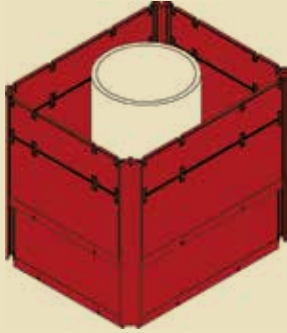

## SQUARE AND RECTANGULAR PITS

**TOP:** Less than 6' from an active railroad track, this 8' deep x 10' wide x 12' long single slide rail system proved through practice and engineering that it could handle the load.

**CENTER:** With a Komatsu PC 300, this double slide rail system, measuring 20' deep x 10' wide x 18' long was installed in the middle of an active parking lot, allowing the crew to install an 8.5' O.D. lift station.

**BOTTOM:** Using two Hitachi EX 700 machines, this 24' deep, 20' wide x 20' long triple slide rail system was used to install a large, 14' O.D. lift station.



Leading producer and distributor of trench shielding & shoring equipment since 1995

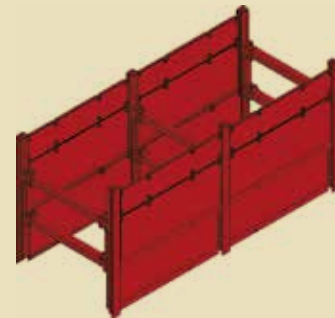

## LINEAR AND MULTIPLE BAYS

**TOP:** At 12' in depth, this single slide rail system was used to provide protection for a crew while they were installing pipe. With the slide rail system being a low vibration alternative to tight sheeting, this project was able to be completed while being next to a building with sensitive computer equipment.

**CENTER:** With an active lift station, a road and a river a stone's throw away, this 12' deep, 16' wide x 50' long linear system was used to install three pressure reduction valves for a new light rail system.

**BOTTOM:** With over 600,000 pounds of slide rail equipment on this job, this 24' deep x 18' wide x 146' long system was used to find and repair pipe line in the Louisiana wetlands.

# FLEXIBLE COMPONENTS

makes installation easier, faster and more economical

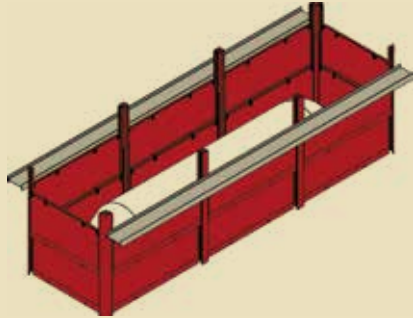

## CLEAR SPAN TANK INSTALLATIONS

**TOP:** Measuring 12' deep x 12' wide x 69' long (using 4 bays of 16' panels), multiple fuel tanks are installed at Detroit Metro Airport with the aid of a PC 600 Komatsu excavator.

**CENTER:** Using a CAT 330 machine this 16' deep x 18' wide x 65' long system was installed at a hospital to provide them with an external fuel tank. Being outside a hospital, it was a necessity that this fuel tank be installed with a low vibration system, while providing workers with a safe workzone.

**BOTTOM:** With a Hitachi 450 and a CAT 345 excavator, this very large C.I.P. project measured in at 24' deep x 30' wide x 50' long.





Leading producer and distributor of trench shielding & shoring equipment since 1995

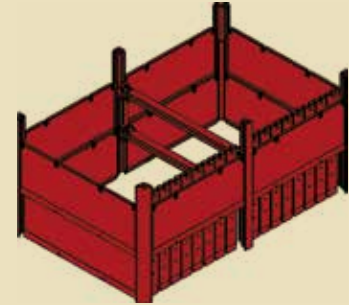

## CUSTOM DESIGNS TO MEET UNIQUE NEEDS

**TOP:** 11' deep x 14' wide x over 100' long, this green corn receiving pit was done by "leap-frogging" the system as the crew poured the walls. Requiring no less than 10' of vertical clearance for the walls, the system was able to brace off the cured concrete floor, while itself acting as the forms for the walls.

**CENTER:** This double slide rail system shows the versatility of slide rail. With a mixture of a clearspan system (to allow the installation of three fuel tanks) and a multiple bay system while displaying the Pro-Tec Equipment box beam roller system (which allows an additional 27" of vertical clearance).

**BOTTOM:** With side-by-side utility panel guides, this 28' deep x 42' long x 20' wide system was used to search for a problem area on active pipe adjacent to a busy highway.

# SYSTEM ACCESSORIES

Helpful items for use on the jobsite

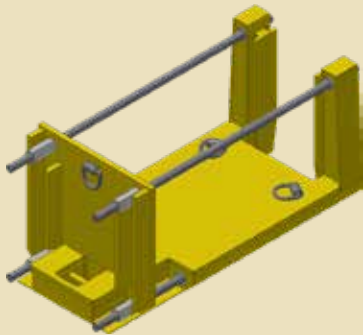

## ACCESSORIES

**TOP:** The Pro-Tec Equipment Tie Back Bracket. Designed with jobsite safety in mind, the Tie Back Bracket is able to accept multiple sizes of external water beams and aids in the completion of clearspan applications.

**CENTER:** How you start determines how you finish. That is why Pro-Tec Equipment has the squaring and alignment tools. The squaring tool allows end users to check and make sure the starting panels are all square, allowing the pit to be installed and removed with minimal or zero binding.

**BOTTOM:** The alignment tools (for the corner post and the spreader post) assure that the panels are in the proper position prior to placing the required post



Leading producer and distributor of trench shielding & shoring equipment since 1995

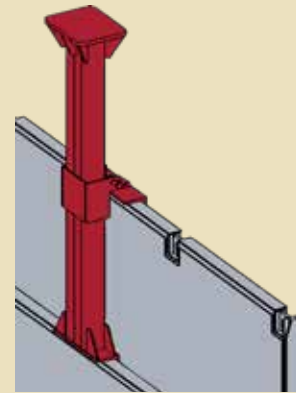

## CUSTOM DESIGNS TO MEET UNIQUE NEEDS

**TOP:** The Pro-Tec Equipment P.I.T. Boss is a patented slide rail panel installation tool that dramatically increases the speed of placement of the entire system.

It solves the problem of having limited access to panel push points, thereby increasing both the speed and effectiveness of installation. At the same time, the tool reduces wear and tear on the panels and on the excavator bucket used during placement.

**CENTER:** The DRB-8A is a pipe adapter that enables the use of 8" sch. 80 spreader pipes as spreader beams on Double Slide Rail Systems. The DRB-8A is designed to allow the use of standard size 8" sch. 80 spreader pipes. When using the new system, the spreader pipe used needs to be 2' shorter than the panel size.

**BOTTOM:** Pro-Tec Equipment's railing post system serves as an extra precautionary measure, providing temporary railing around excavations that involve trench shoring and shielding.

Certified by a Registered Professional Engineer to meet or exceed O.S.H.A. handrail standards, the railing post systems are two-piece, lightweight systems that can be adapted to work with steel and aluminum trench shoring and shielding systems.



**PRO-TEC EQUIPMENT**

4837 West Grand River Ave  
Lansing, MI 48906  
Phone: 1-800-292-1225  
Fax: (517) 827-3263  
[www.pro-tecequipment.com](http://www.pro-tecequipment.com)

The information in this brochure is presented in good faith to assist the user in determining whether our products are suitable for his/her application. No warranty or representation, however, is intended or made, nor is protection from any law or patent to be inferred, and all patent rights are reserved. Job site photos are strictly intended for general product information only and may not comply with all applicable safety standards. Always refer to manufacturer's specific tabulated data, O.S.H.A. 29 CFR 1926 Subpart P for excavation and all applicable safety standards prior to each use. ©201 Pro-Tec Equipment. All rights reserved.

**ARCOSA**  
SHORING PRODUCTS